

Silent Gliss®

1280 Hand Operated Curtain Track Fitting Instructions

Face Fix or Top Fix with universal bracket 3630

Brackets should be spaced evenly at no more than every 600mm (24") intervals.

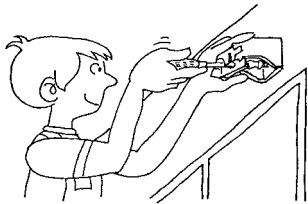
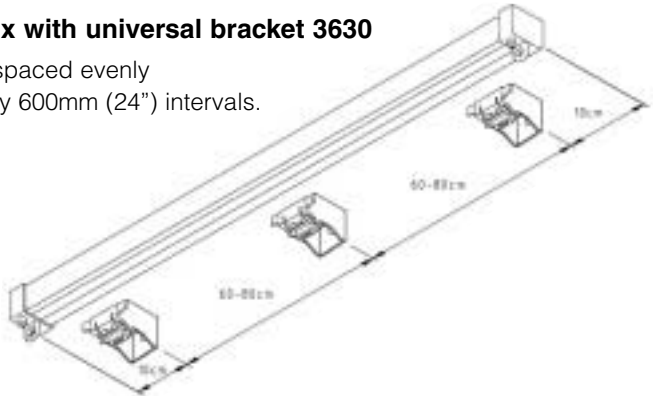

Firmly screw **3630** brackets to wall or ceiling. The two outside brackets should be located 10cm (4") in from the ends of track so as not to coincide with end covers. Remaining brackets should be equally spaced along track approx. every 600mm (24").

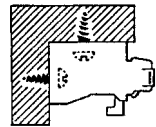

Screw for wall or ceiling with universal bracket.

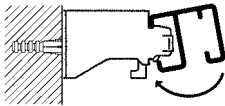

To fit the track, simply push on as shown.

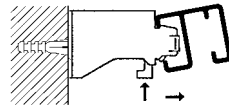

To remove track push forwards and outwards.

Standard Accessories

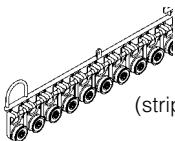

3922
Roller
(strip of 20)

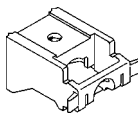

3630
Wall/Ceiling
Bracket

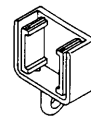

3985
Eyelet
Endcover/
Endstop

P.T.O. These instructions are continued on reverse side.

If you need to shorten your track...

Unscrew and remove endcover and slide gliders to the other end.

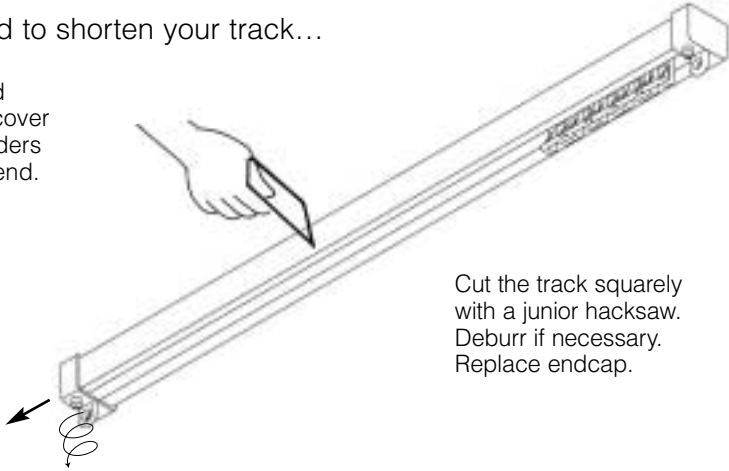

Cut the track squarely with a junior hacksaw. Deburr if necessary. Replace endcap.

Optional/Accessories (not supplied)

A wide range of accessories is available for this most versatile curtain track. ask your dealer.

Fixed extension brackets.

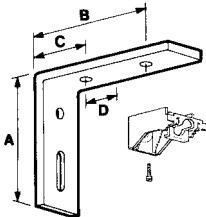

	A	B	C
3134	50	51.5	-
3135	50	71.5	21.5
3136	50	91.5	41.5
3137	80	111.5	61.5
3138	80	141.5	91.5
3139	80	191.5	141.5

(Dimensions in mm)

Adjustable extension brackets.

3275 Adjusts from 77 - 107mm



3276 Adjusts from 100 - 130mm

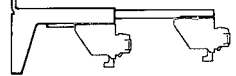

3277 Adjusts from 130 - 160mm

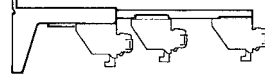

Up to 3 tracks can be located on the same extension bracket or a pelmet formed around your existing track.

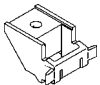

3603
Ceiling Bracket

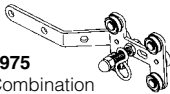

3975
Combination overlap complete with 'S' hook attachment 3949. Use with draw rod.



3932
Spring Stop



3620
Connecting Bridge



3975
Strong overlap for pulling by hand



3942
Endstop/Intermediate stop

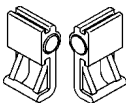

3947
Pair of magnetic gliders

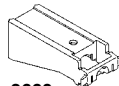

3660
Wall/Ceiling Bracket



3935A
Combination straight overlap complete with 'S' hook attachment 3949. (For use with pair curtains and 3936A above on opposite curtain. Use with draw rod.)



4092
Plastic draw rod
4092S
Aluminium draw rod

THIS TRACK CANNOT BE BENT AT HOME.

Silent Gliss Limited

Star Lane, Margate, Kent CT9 4EF, England
Telephone: 01843 863571 Fax: 01843 864503
E-mail: info@silentgliss.co.uk www.silentgliss.co.uk

